

LONGTECH - LGO12864A-096

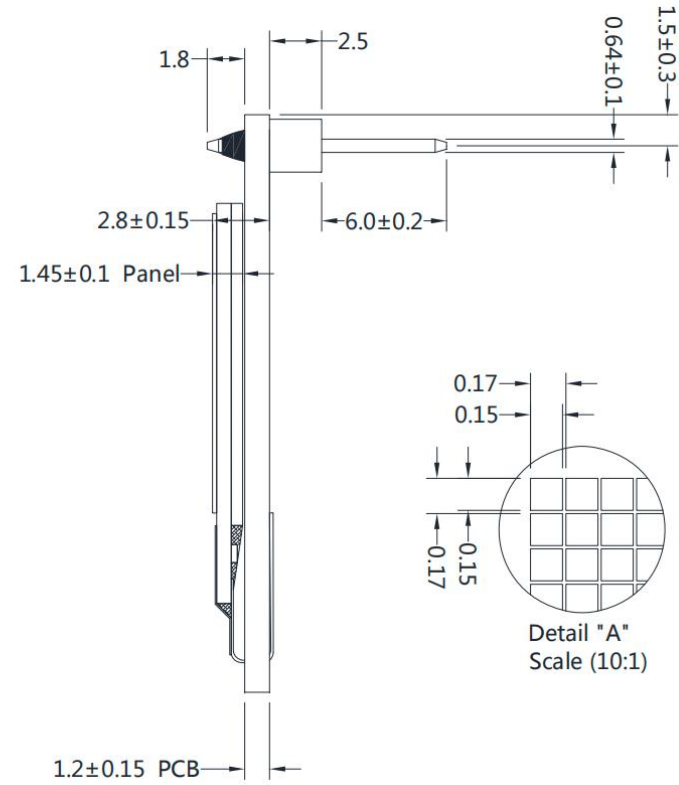
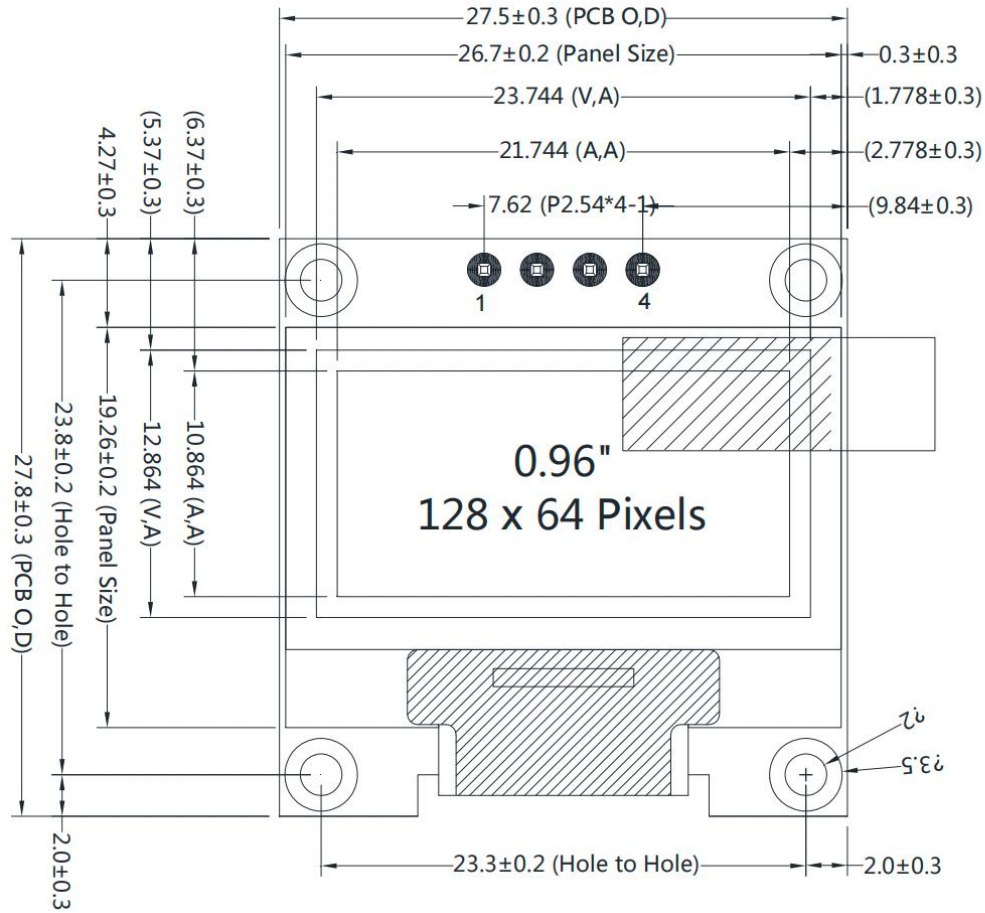

Pin Connection	
1	GND
2	VCC
3	SCL
4	SDA